

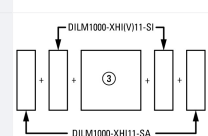

**Contactor, 380 V 400 V 110 kW, 2 N/O, 2 NC, RAC 48: 42 - 48 V 50/60 Hz, AC operation, Screw connection**

**Part no.** DILM225A/22(RAC48)  
**Catalog No.** 139545  
**Alternate Catalog No.** XTCE225H22W  
**EL-Nummer (Norway)** 4134285

**Delivery program**

|   |                |    |  |
|---|----------------|----|--|
| Product range   |                |    | Contactors   |
| Application   |                |    | Contactors for Motors  |
| Subrange  |                |    | Standard devices greater than 170 A  |
| Utilization category  |                |    | AC-1: Non-inductive or slightly inductive loads, resistance furnaces<br>NAC-3: Normal AC induction motors: starting, switch off during running<br>AC-4: Normal AC induction motors: starting, plugging, reversing, inching |
| Connection technique  |                |    | Screw connection   |
| <b>Rated operational current</b>                              |                |    |  |
| AC-3  |                |    |  |
| 380 V 400 V   | $I_e$          | A  | 225  |
| AC-1  |                |    |  |
| Conventional free air thermal current, 3 pole, 50 - 60 Hz     |                |    |  |
| Open  |                |    |  |
| at 40 °C  | $I_{th} = I_e$ | A  | 386  |
| enclosed  | $I_{th}$       | A  | 275  |
| Conventional free air thermal current, 1 pole                 |                |    |  |
| open  | $I_{th}$       | A  | 707  |
| enclosed  | $I_{th}$       | A  | 636  |
| <b>Max. rating for three-phase motors, 50 - 60 Hz</b>         |                |    |  |
| AC-3  |                |    |  |
| 220 V 230 V   | P              | kW | 70   |
| 380 V 400 V   | P              | kW | 110  |
| 660 V 690 V   | P              | kW | 150  |
| 1000 V  | P              | kW | 108  |
| AC-4  |                |    |  |
| 220 V 230 V   | P              | kW | 51   |
| 380 V 400 V   | P              | kW | 90   |
| 660 V 690 V   | P              | kW | 110  |
| 1000 V  | P              | kW | 77   |
| Contact sequence  |                |    |    |
| Can be combined with auxiliary contact                        |                |    | DILM1000-XHI...  |
| Actuating voltage   |                |    | RAC 48: 42 - 48 V 50/60 Hz   |
| Voltage AC/DC   |                |    | AC operation   |
| <b>Contacts</b>   |                |    |  |
| N/O = Normally open   |                |    | 2 N/O  |
| N/C = Normally closed   |                |    | 2 NC   |
| <b>Auxiliary contacts</b>                                     |                |    |  |
| possible variants at auxiliary contact module fitting options |                |    | on the side: 2 x DILM1000-XHI(V)11-SI; 2 x DILM1000-XHI11-SA   |
| Side mounting auxiliary contacts                              |                |    |    |
| <b>Instructions</b>   |                |    | Interlocked opposing contacts according to IEC/EN 60947-5-1 Appendix L, inside the auxiliary contact module  |

|                     |  |  |
|---------------------|--|--|
|                     |  | Auxiliary contacts used as mirror contacts according to IEC/EN 60947-4-1 Appendix F (not N/C late open)  |
| <b>Instructions</b> |  | integrated suppressor circuit in actuating electronics<br>660 V, 690 V or 1000 V: not directly reversing |

## Technical data

### General

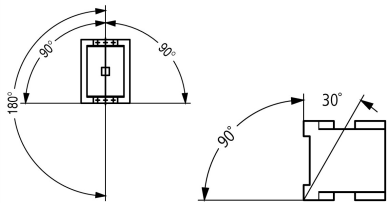
|   |                                     |                 |   |
|---|-------------------------------------|-----------------|---|
| Standards   |                                     |                 | IEC/EN 60947, VDE 0660, UL, CSA   |
| Lifespan, mechanical  |                                     |                 |   |
| AC operated   | Operations                          | $\times 10^6$   | 10  |
| Operating frequency, mechanical                                       |                                     |                 |   |
| AC operated   | Operations/h                        |                 | 3000  |
| Climatic proofing   |                                     |                 | Damp heat, constant, to IEC 60068-2-78<br>Damp heat, cyclic, to IEC 60068-2-30                              |
| Ambient temperature   |                                     |                 |   |
| Open  |                                     | °C              | -40 - +60   |
| Enclosed  |                                     | °C              | - 40 - + 40   |
| Storage   |                                     | °C              | - 40 - + 80   |
| Mounting position   |                                     |                 |                           |
| Mechanical shock resistance (IEC/EN 60068-2-27)                       |                                     |                 |   |
| Half-sinusoidal shock, 10 ms  |                                     |                 |   |
| Main contacts   |                                     |                 |   |
| N/O contact   |                                     | g               | 10  |
| Auxiliary contacts  |                                     |                 |   |
| N/O contact   |                                     | g               | 10  |
| N/C contact   |                                     | g               | 8   |
| Degree of Protection  |                                     |                 | IP00  |
| Protection against direct contact when actuated from front (EN 50274) |                                     |                 | Finger and back-of-hand proof with terminal shroud or terminal block  |
| Altitude  |                                     | m               | Max. 2000   |
| Weight  |                                     |                 |   |
| AC operated   |                                     | kg              | 3.54  |
| DC operated   |                                     | kg              | 3.54  |
| Weight  |                                     | kg              | 3.54  |
| Terminal capacity main cable  |                                     |                 |   |
| Flexible with cable lug   |                                     | mm <sup>2</sup> | 50 - 185  |
| Stranded with cable lug   |                                     | mm <sup>2</sup> | 70 - 185  |
| Solid or stranded   |                                     | AWG             | 2/0 - 250 MCM   |
| Flat conductor  | Lamellenzahl<br>x Breite x<br>Dicke | mm              | Fixing with flat cable terminal or cable terminal blocks<br>See terminal capacity for cable terminal blocks |
| Busbar  | Width                               | mm              | 32  |
| Main cable connection screw/bolt                                      |                                     |                 | M10   |
| Tightening torque   |                                     | Nm              | 24  |
| Terminal capacity control circuit cables                              |                                     |                 |   |
| Solid   |                                     | mm <sup>2</sup> | 1 x (0.75 - 2.5)<br>2 x (0.75 - 2.5)  |
| Flexible with ferrule   |                                     | mm <sup>2</sup> | 1 x (0.75 - 2.5)<br>2 x (0.75 - 2.5)  |
| Solid or stranded   |                                     | AWG             | 18 - 14   |
| Control circuit cable connection screw/bolt                           |                                     |                 | M3.5  |
| Tightening torque   |                                     | Nm              | 1.2   |
| Tool  |                                     |                 |   |
| Main cable  |                                     |                 |   |

|                        |      |    |
|------------------------|------|----|
| Width across flats     | mm   | 16 |
| Control circuit cables |      |    |
| Pozidriv screwdriver   | Size | 2  |

### Main conducting paths

|  |              |      |   |
|--|--------------|------|---|
| Rated impulse withstand voltage        | $U_{imp}$    | V AC | 8000  |
| Overvoltage category/pollution degree  |              |      | III/3   |
| Rated insulation voltage               | $U_i$        | V AC | 1000  |
| Rated operational voltage              | $U_e$        | V AC | 1000  |
| Safe isolation to EN 61140             |              |      |   |
| between coil and contacts              |              | V AC | 500   |
| between the contacts                   |              | V AC | 500   |
| Making capacity (p.f. to IEC/EN 60947) |              | A    | 2700  |
| Breaking capacity                      |              |      |   |
| 220 V 230 V                            |              | A    | 2250  |
| 380 V 400 V                            |              | A    | 2250  |
| 500 V                                  |              | A    | 2250  |
| 660 V 690 V                            |              | A    | 2250  |
| 1000 V                                 |              | A    | 760   |
| Component lifespan                     |              |      | AC1: See → Engineering, characteristic curves<br>AC3: See → Engineering, characteristic curves<br>AC4: See → Engineering, characteristic curves |
| Short-circuit rating                   |              |      |   |
| Short-circuit protection maximum fuse  |              |      |   |
| Type "2" coordination                  |              |      |   |
| 400 V                                  | gG/gL 500 V  | A    | 315   |
| 690 V                                  | gG/gL 690 V  | A    | 250   |
| 1000 V                                 | gG/gL 1000 V | A    | 160   |
| Type "1" coordination                  |              |      |   |
| 400 V                                  | gG/gL 500 V  | A    | 400   |
| 690 V                                  | gG/gL 690 V  | A    | 315   |
| 1000 V                                 | gG/gL 1000 V | A    | 200   |

### AC

|   |                |   |  |
|---|----------------|---|--|
| AC-1  |                |   |  |
| Rated operational current                                 |                |   |  |
| Conventional free air thermal current, 3 pole, 50 - 60 Hz |                |   |  |
| Open  |                |   |  |
| at 40 °C  | $I_{th} = I_e$ | A | 386  |
| at 50 °C  | $I_{th} = I_e$ | A | 345  |
| at 55 °C  | $I_{th} = I_e$ | A | 329  |
| at 60 °C  | $I_{th} = I_e$ | A | 315  |
| enclosed  | $I_{th}$       | A | 275  |
| Notes   |                |   | At maximum permissible ambient air temperature.    |
| Conventional free air thermal current, 1 pole             |                |   |  |
| Note  |                |   | at maximum permissible ambient air temperature     |
| open  | $I_{th}$       | A | 707  |
| enclosed  | $I_{th}$       | A | 636  |
| AC-3  |                |   |  |
| Rated operational current                                 |                |   |  |
| Open, 3-pole: 50 – 60 Hz                                  |                |   |  |
| Notes   |                |   | At maximum permissible ambient temperature (open.) |
| 220 V 230 V   | $I_e$          | A | 225  |
| 240 V   | $I_e$          | A | 225  |
| 380 V 400 V   | $I_e$          | A | 225  |
| 415 V   | $I_e$          | A | 225  |

|              |                |     |     |
|--------------|----------------|-----|-----|
| 440V         | I <sub>e</sub> | A   | 225 |
| 500 V        | I <sub>e</sub> | A   | 225 |
| 660 V 690 V  | I <sub>e</sub> | A   | 160 |
| 1000 V       | I <sub>e</sub> | A   | 76  |
| Motor rating | P              | kWh |     |
| 220 V 230 V  | P              | kW  | 70  |
| 240V         | P              | kW  | 75  |
| 380 V 400 V  | P              | kW  | 110 |
| 415 V        | P              | kW  | 132 |
| 440 V        | P              | kW  | 138 |
| 500 V        | P              | kW  | 160 |
| 660 V 690 V  | P              | kW  | 150 |
| 1000 V       | P              | kW  | 108 |

#### AC-4

|                           |                |     |     |
|---------------------------|----------------|-----|-----|
| Rated operational current |                |     |     |
| Open, 3-pole: 50 – 60 Hz  |                |     |     |
| 220 V 230 V               | I <sub>e</sub> | A   | 164 |
| 240 V                     | I <sub>e</sub> | A   | 164 |
| 380 V 400 V               | I <sub>e</sub> | A   | 164 |
| 415 V                     | I <sub>e</sub> | A   | 164 |
| 440 V                     | I <sub>e</sub> | A   | 164 |
| 500 V                     | I <sub>e</sub> | A   | 164 |
| 660 V 690 V               | I <sub>e</sub> | A   | 120 |
| 1000 V                    | I <sub>e</sub> | A   | 55  |
| Motor rating              | P              | kWh |     |
| 220 V 230 V               | P              | kW  | 51  |
| 240 V                     | P              | kW  | 54  |
| 380 V 400 V               | P              | kW  | 90  |
| 415 V                     | P              | kW  | 96  |
| 440 V                     | P              | kW  | 102 |
| 500 V                     | P              | kW  | 116 |
| 660 V 690 V               | P              | kW  | 110 |
| 1000 V                    | P              | kW  | 77  |

#### Condensator operation

|   |            |                   |     |
|---|------------|-------------------|-----|
| Individual compensation, rated operational current I <sub>e</sub> of three-phase capacitors |            |                   |     |
| Open  |            |                   |     |
| up to 525 V   |            | A                 | 220 |
| 690 V   |            | A                 | 133 |
| Max. inrush current peak  |            | x I <sub>e</sub>  | 30  |
| Component lifespan  | Operations | x 10 <sup>6</sup> | 0.1 |
| Max. operating frequency  |            | Ops/h             | 200 |

#### DC

|                                 |  |  |                                     |
|---------------------------------|--|--|-------------------------------------|
| Rated operational current, open |  |  |                                     |
| DC-1                            |  |  |                                     |
| Notes                           |  |  | see DILDC300/DILDC600 or on request |

#### Current heat loss

|   |  |    |      |
|---|--|----|------|
| 3 pole, at I <sub>th</sub> (60°)                  |  | W  | 45   |
| Current heat loss at I <sub>e</sub> to AC-3/400 V |  | W  | 23   |
| Impedance per pole                                |  | mΩ | 0.15 |

#### Magnet systems

|                   |          |  |  |
|-------------------|----------|--|--|
| Voltage tolerance |          |  |  |
| U <sub>S</sub>    |          |  | 48 - 110 V 40-60 Hz                                  |
| AC operated       | Pick-up  |  | 0.8 x U <sub>S min</sub> - 1.15 x U <sub>S max</sub> |
| AC operated       | Drop-out |  | 0.25 x U <sub>S min</sub> - 0.6 x U <sub>S max</sub> |

|  |         |      |     |
|--|---------|------|-----|
| Power consumption of the coil in a cold state and 1.0 x U <sub>S</sub> |         |      |     |
| Pull-in power  | Pick-up | VA   | 210 |
| Pull-in power  | Pick-up | W    | 180 |
| Sealing power  | Sealing | VA   | 2.6 |
| Sealing power  | Sealing | W    | 2.1 |
| Duty factor  |         | % DF | 100 |
| Changeover time at 100 % U <sub>S</sub> (recommended value)            |         |      |     |
| Main contacts  |         |      |     |
| Closing delay  |         | ms   | 60  |
| Opening delay  |         | ms   | 40  |

### Electromagnetic compatibility (EMC)

|                               |  |  |   |
|-------------------------------|--|--|---|
| Electromagnetic compatibility |  |  | This product is designed for operation in industrial environments (environment A). Its use in residential environments (environment B) may cause radio-frequency interference, requiring additional noise suppression measures. |
|-------------------------------|--|--|---|

### Rating data for approved types

|   |  |    |             |
|---|--|----|-------------|
| Switching capacity  |  |    |             |
| Maximum motor rating                                      |  |    |             |
| Three-phase   |  |    |             |
| 200 V<br>208 V  |  | HP | 60          |
| 230 V<br>240 V  |  | HP | 75          |
| 460 V<br>480 V  |  | HP | 150         |
| 575 V<br>600 V  |  | HP | 200         |
| General use   |  | A  | 250         |
| Auxiliary contacts  |  |    |             |
| Pilot Duty  |  |    |             |
| AC operated   |  |    | A600        |
| DC operated   |  |    | P300        |
| General Use   |  |    |             |
| AC  |  | V  | 600         |
| AC  |  | A  | 15          |
| DC  |  | V  | 250         |
| DC  |  | A  | 1           |
| Short Circuit Current Rating                              |  |    |             |
| Basic Rating  |  |    |             |
| SCCR  |  | kA | 10          |
| max. Fuse   |  | A  | 700         |
| max. CB   |  | A  | 600         |
| 480 V High Fault  |  |    |             |
| SCCR (fuse)   |  | kA | 100         |
| max. Fuse   |  | A  | 600 Class J |
| SCCR (CB)   |  | kA | 65          |
| max. CB   |  | A  | 350         |
| 600 V High Fault  |  |    |             |
| SCCR (fuse)   |  | kA | 100         |
| max. Fuse   |  | A  | 600 Class J |
| SCCR (CB)   |  | kA | 50          |
| max. CB   |  | A  | 350         |
| Special Purpose Ratings                                   |  |    |             |
| Definite Purpose Ratings (100,000 cycles acc. to UL 1995) |  |    |             |
| LRA 480V 60Hz 3phase                                      |  | A  | 2016        |
| FLA 480V 60Hz 3phase                                      |  | A  | 336         |
| LRA 600V 60Hz 3phase                                      |  | A  | 1680        |
| FLA 600V 60Hz 3phase                                      |  | A  | 280         |

## Design verification as per IEC/EN 61439

| Technical data for design verification   |            |    |  |
|--|------------|----|--|
| Rated operational current for specified heat dissipation   | $I_n$      | A  | 225  |
| Heat dissipation per pole, current-dependent   | $P_{vid}$  | W  | 7.67   |
| Equipment heat dissipation, current-dependent  | $P_{vid}$  | W  | 0  |
| Static heat dissipation, non-current-dependent   | $P_{vs}$   | W  | 2.1  |
| Heat dissipation capacity  | $P_{diss}$ | W  | 0  |
| Operating ambient temperature min.   |            | °C | -40  |
| Operating ambient temperature max.   |            | °C | 60   |
| IEC/EN 61439 design verification   |            |    |  |
| 10.2 Strength of materials and parts   |            |    |  |
| 10.2.2 Corrosion resistance  |            |    |  |
|  |            |    | Meets the product standard's requirements.   |
| 10.2.3.1 Verification of thermal stability of enclosures   |            |    |  |
|  |            |    | Meets the product standard's requirements.   |
| 10.2.3.2 Verification of resistance of insulating materials to normal heat   |            |    |  |
|  |            |    | Meets the product standard's requirements.   |
| 10.2.3.3 Verification of resistance of insulating materials to abnormal heat and fire due to internal electric effects |            |    |  |
|  |            |    | Meets the product standard's requirements.   |
| 10.2.4 Resistance to ultra-violet (UV) radiation   |            |    |  |
|  |            |    | Meets the product standard's requirements.   |
| 10.2.5 Lifting   |            |    |  |
|  |            |    | Does not apply, since the entire switchgear needs to be evaluated.   |
| 10.2.6 Mechanical impact   |            |    |  |
|  |            |    | Does not apply, since the entire switchgear needs to be evaluated.   |
| 10.2.7 Inscriptions  |            |    |  |
|  |            |    | Meets the product standard's requirements.   |
| 10.3 Degree of protection of ASSEMBLIES  |            |    |  |
|  |            |    | Does not apply, since the entire switchgear needs to be evaluated.   |
| 10.4 Clearances and creepage distances   |            |    |  |
|  |            |    | Meets the product standard's requirements.   |
| 10.5 Protection against electric shock   |            |    |  |
|  |            |    | Does not apply, since the entire switchgear needs to be evaluated.   |
| 10.6 Incorporation of switching devices and components   |            |    |  |
|  |            |    | Does not apply, since the entire switchgear needs to be evaluated.   |
| 10.7 Internal electrical circuits and connections  |            |    |  |
|  |            |    | Is the panel builder's responsibility.   |
| 10.8 Connections for external conductors   |            |    |  |
|  |            |    | Is the panel builder's responsibility.   |
| 10.9 Insulation properties   |            |    |  |
| 10.9.2 Power-frequency electric strength   |            |    |  |
|  |            |    | Is the panel builder's responsibility.   |
| 10.9.3 Impulse withstand voltage   |            |    |  |
|  |            |    | Is the panel builder's responsibility.   |
| 10.9.4 Testing of enclosures made of insulating material   |            |    |  |
|  |            |    | Is the panel builder's responsibility.   |
| 10.10 Temperature rise   |            |    |  |
|  |            |    | The panel builder is responsible for the temperature rise calculation. Eaton will provide heat dissipation data for the devices. |
| 10.11 Short-circuit rating   |            |    |  |
|  |            |    | Is the panel builder's responsibility. The specifications for the switchgear must be observed.                                   |
| 10.12 Electromagnetic compatibility  |            |    |  |
|  |            |    | Is the panel builder's responsibility. The specifications for the switchgear must be observed.                                   |
| 10.13 Mechanical function  |            |    |  |
|  |            |    | The device meets the requirements, provided the information in the instruction leaflet (IL) is observed.                         |

## Technical data ETIM 7.0

| Low-voltage industrial components (EG000017) / Power contactor, AC switching (EC000066)   |  |    |                 |
|---|--|----|-----------------|
| Electric engineering, automation, process control engineering / Low-voltage switch technology / Contactor (LV) / Power contactor, AC switching (ecl@ss10.0.1-27-37-10-03 [AAB718015]) |  |    |                 |
| Rated control supply voltage $U_s$ at AC 50HZ   |  | V  | 48 - 110        |
| Rated control supply voltage $U_s$ at AC 60HZ   |  | V  | 48 - 110        |
| Rated control supply voltage $U_s$ at DC  |  | V  | 0 - 0           |
| Voltage type for actuating  |  |    | AC              |
| Rated operation current $I_e$ at AC-1, 400 V  |  | A  | 356             |
| Rated operation current $I_e$ at AC-3, 400 V  |  | A  | 225             |
| Rated operation power at AC-3, 400 V  |  | kW | 110             |
| Rated operation current $I_e$ at AC-4, 400 V  |  | A  | 164             |
| Rated operation power at AC-4, 400 V  |  | kW | 90              |
| Rated operation power NEMA  |  | kW | 111             |
| Modular version   |  |    | No              |
| Number of auxiliary contacts as normally open contact   |  |    | 2               |
| Number of auxiliary contacts as normally closed contact   |  |    | 2               |
| Type of electrical connection of main circuit   |  |    | Rail connection |
| Number of normally closed contacts as main contact  |  |    | 0               |

Number of main contacts as normally open contact

3

## Approvals

|                                      |  |
|--------------------------------------|--|
| Product Standards                    | IEC/EN 60947-4-1; UL 60947-4-1; CSA - C22.2 No. 60947-4-1-14; CE marking |
| UL File No.                          | E29096   |
| UL Category Control No.              | NLDX   |
| CSA File No.                         | 2389068  |
| CSA Class No.                        | 3211-04  |
| North America Certification          | UL listed, CSA certified   |
| Specially designed for North America | No   |

## Characteristics

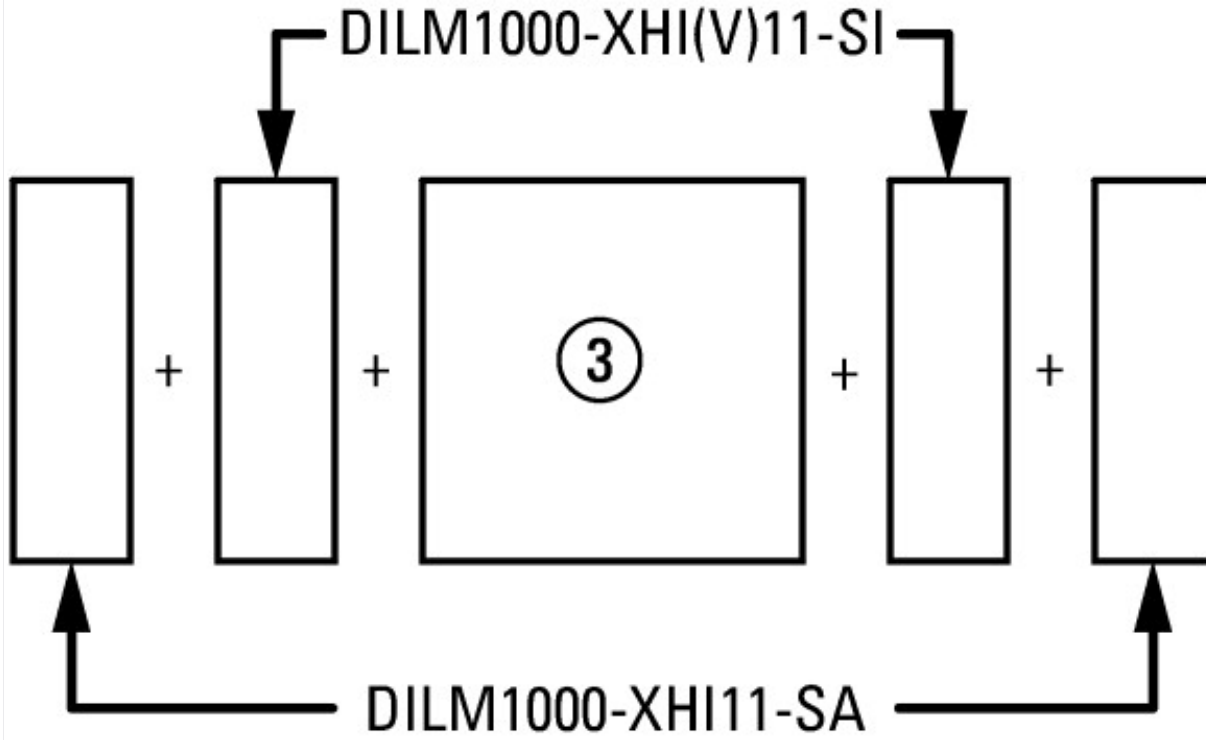

on the side: 2 x DILM1000-XHI(V)11-SI; 2 x DILM1000-XHI11-SA

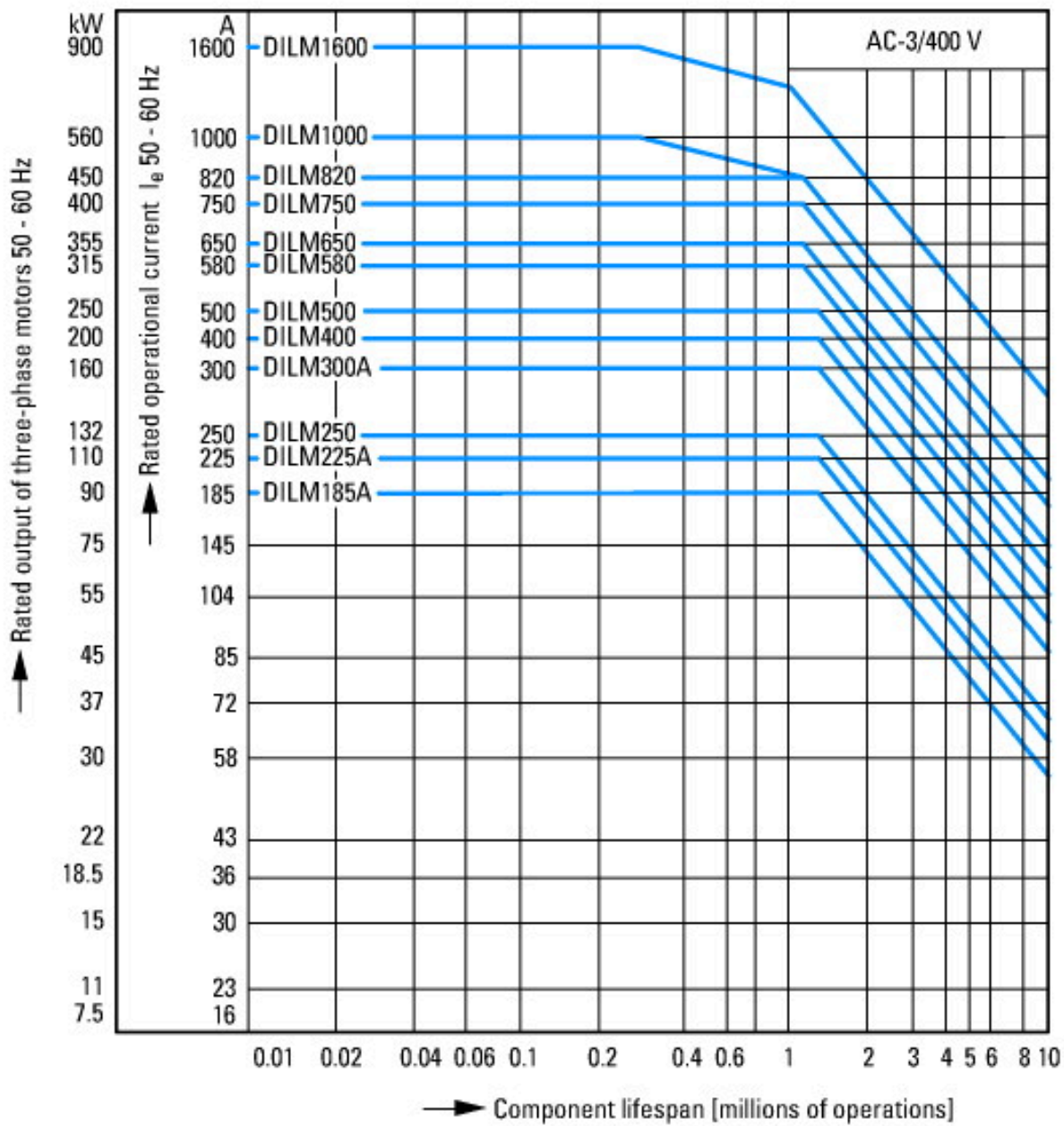

Normal switching duty  
 Normal AC induction motor  
 Operating characteristics  
 Switch on: from stop  
 Switch off: during run  
 Electrical characteristics:  
 Switch on: up to 6 x Rated motor current  
 Switch off: up to 1 x Rated motor current  
 Utility category  
 100 % AC-3  
 Typical Applications  
 Compressors  
 Lifts  
 Mixers  
 Pumps  
 Escalators  
 Agitators  
 fan  
 Conveyor belts  
 Centrifuges  
 Hinged flaps  
 Bucket-elevator  
 Air-conditioning systems  
 General drives for manufacturing and processing machines

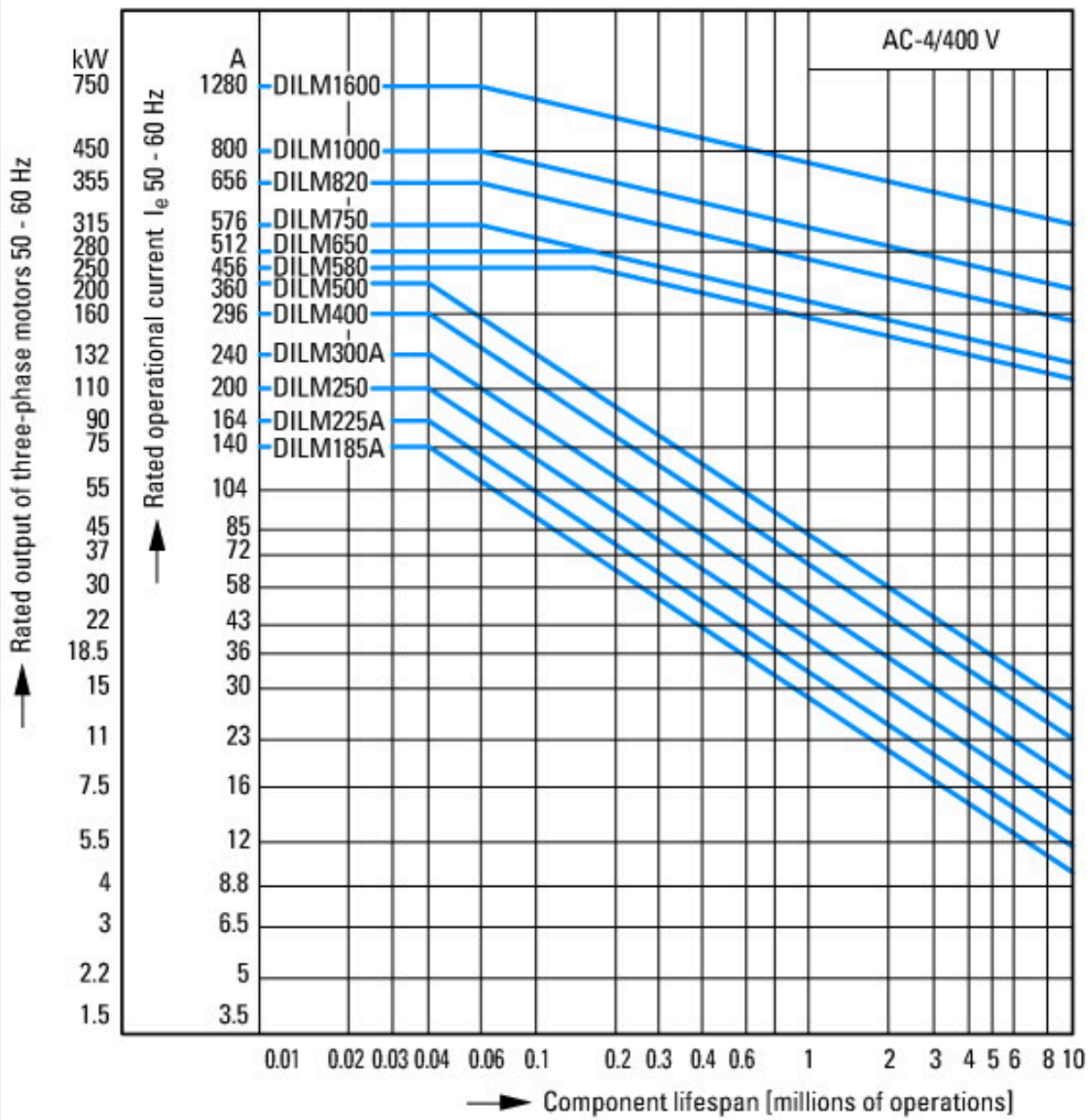

Extreme switching duty  
 Squirrel-cage motor  
 Operating characteristics  
 Inching, plugging, reversing  
 Electrical characteristics  
 Make: up to 6 x rated motor current  
 Break: up to 6 x rated motor current  
 Utilization category  
 100 % AC-4  
 Typical applications  
 Printing presses  
 Wire-drawing machines  
 Centrifuges  
 Special drives for manufacturing and processing machines

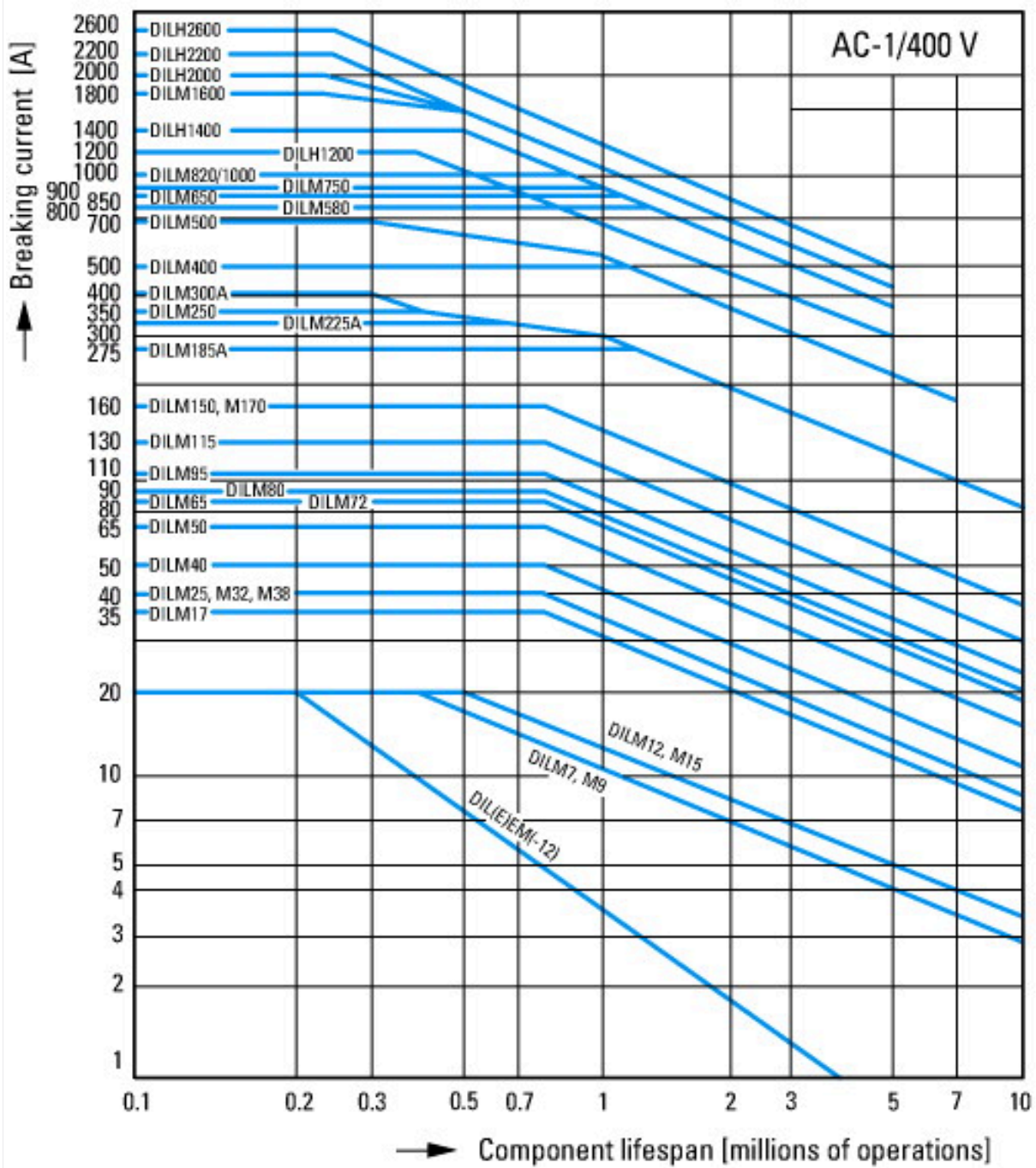

Switching conditions for 3 pole, non-motor loads  
 Operating characteristics  
 Non inductive and slightly inductive loads  
 Electrical characteristics  
 Switch on: 1 x rated operational current  
 Switch off: 1 x rated operational current  
 Utilization category  
 100 % AC-1  
 Typical examples of application  
 Electric heat

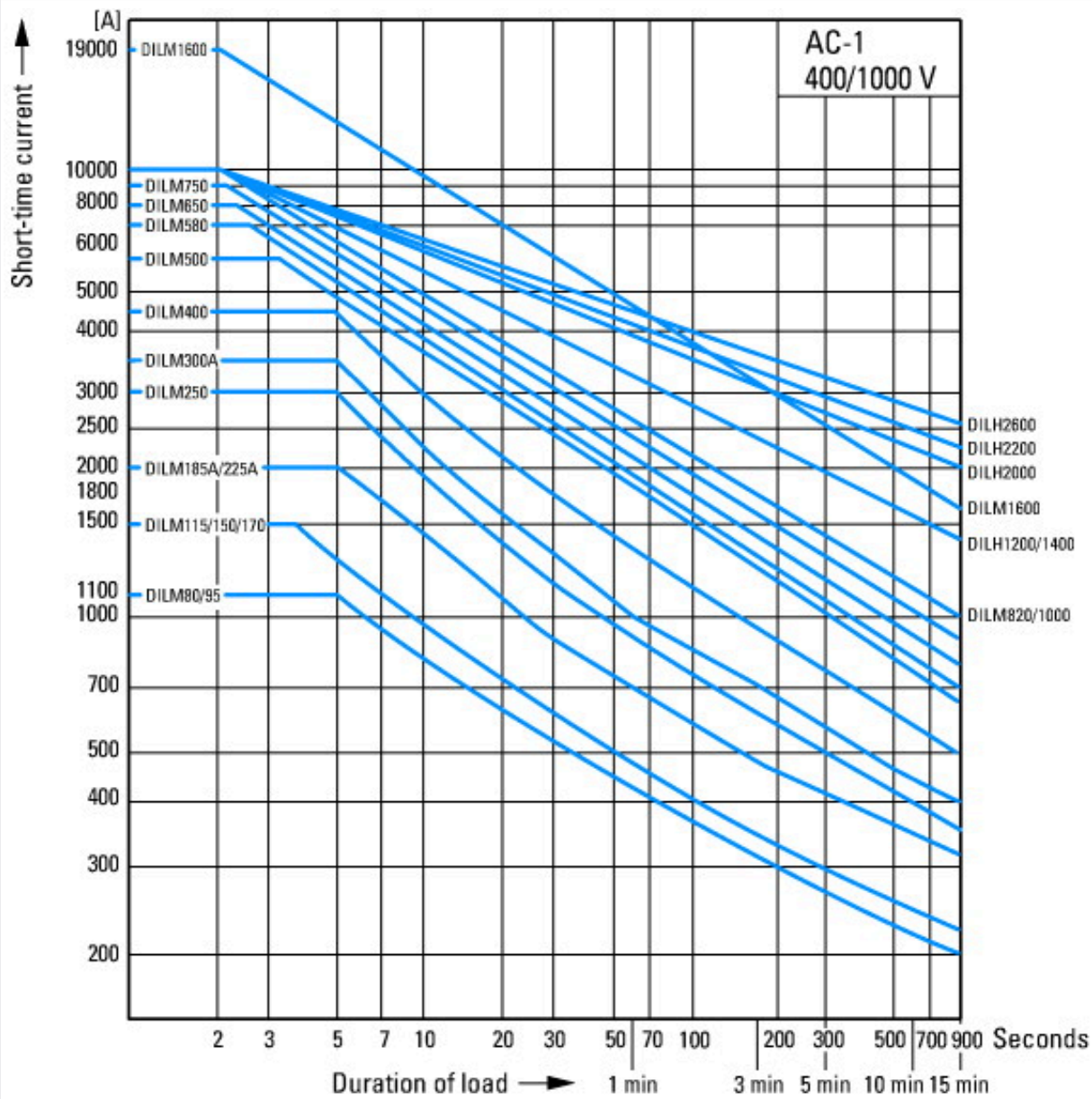

Short-time loading, 3-pole  
Time interval between two loading cycles: 15 minutes

## Dimensions

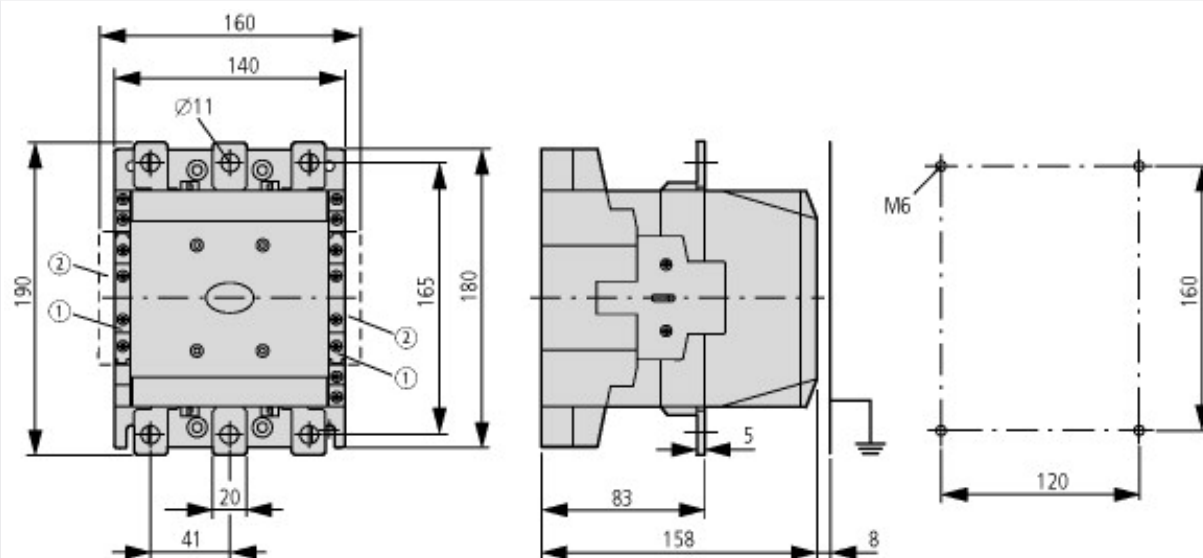

- ① DILM1000-XHI(V)11-SI
- ② DILM1000-XHI11-SA

## Additional product information (links)

| IL03406001Z Contactors   |   |
|--|---|
| IL03406001Z Contactors   | <a href="https://es-assets.eaton.com/DOCUMENTATION/AWA_INSTRUCTIONS/IL03406001Z2018_04.pdf">https://es-assets.eaton.com/DOCUMENTATION/AWA_INSTRUCTIONS/IL03406001Z2018_04.pdf</a>                               |
| Motor starters and "Special Purpose Ratings" for the North American market                     | <a href="http://www.eaton.eu/ecm/groups/public/@pub/@europe/@electrical/documents/content/pct_3258146.pdf">http://www.eaton.eu/ecm/groups/public/@pub/@europe/@electrical/documents/content/pct_3258146.pdf</a> |
| Switchgear of Power Factor Correction Systems  | <a href="http://www.moeller.net/binary/ver_techpapers/ver934en.pdf">http://www.moeller.net/binary/ver_techpapers/ver934en.pdf</a>   |
| X-Start - Modern Switching Installations Efficiently Fitted and Wired Securely                 | <a href="http://www.moeller.net/binary/ver_techpapers/ver938en.pdf">http://www.moeller.net/binary/ver_techpapers/ver938en.pdf</a>   |
| Mirror Contacts for Highly-Reliable Information Relating to Safety-Related Control Functions   | <a href="http://www.moeller.net/binary/ver_techpapers/ver944en.pdf">http://www.moeller.net/binary/ver_techpapers/ver944en.pdf</a>   |
| Effect of the Cable Capacitance of Long Control Cables on the Actuation of Contactors          | <a href="http://www.moeller.net/binary/ver_techpapers/ver949en.pdf">http://www.moeller.net/binary/ver_techpapers/ver949en.pdf</a>   |
| Switchgear for Luminaires  | <a href="http://www.moeller.net/binary/ver_techpapers/ver955en.pdf">http://www.moeller.net/binary/ver_techpapers/ver955en.pdf</a>   |
| Standard Compliant and Functionally Safe Engineering Design with Mechanical Auxiliary Contacts | <a href="http://www.moeller.net/binary/ver_techpapers/ver956en.pdf">http://www.moeller.net/binary/ver_techpapers/ver956en.pdf</a>   |
| The Interaction of Contactors with PLCs  | <a href="http://www.moeller.net/binary/ver_techpapers/ver957en.pdf">http://www.moeller.net/binary/ver_techpapers/ver957en.pdf</a>   |
| Busbar Component Adapters for modern Industrial control panels                                 | <a href="http://www.moeller.net/binary/ver_techpapers/ver960en.pdf">http://www.moeller.net/binary/ver_techpapers/ver960en.pdf</a>   |